

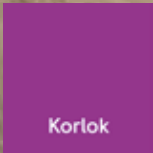

Karndean
Designflooring



Kortok **Commercial**



Installs over
existing hard floors
and hides subfloor
imperfections

Washed Grey Ash RKP8104

Why Korlok?

Unlike laminates and wood flooring Korlok is completely waterproof making it a great choice in wet areas such as bathrooms and kitchens with the added benefit of an R10 slip rating. Korlok's unique K-Core technology and added acoustic backing tolerates up to 5mm variation in subfloor imperfections, allowing drop lock over existing hard floors – saving you time and money. With no requirement for adhesive, additional savings are added into your next project when selecting Korlok flooring.



Acoustic qualities

Superior noise reduction surpassing both Australian and New Zealand acoustic requirements.

ISO717.2 = L_{nw} 52dB | ASTM E492-09 = IIC 62dB



Installs over existing hard floors

Korlok can be installed over most existing hard floor coverings, including ceramic and porcelain tiles.



Waterproof

Unlike laminate and wood flooring, Korlok is completely waterproof, making it a great choice for commercial areas that are prone to spills or splashes.



Quick and easy to install

With a single action installation method, Korlok's 5G mechanism means the fitter can quickly click and lock the planks together.



Featuring Australian Woods

Native Australian species featured heavily in this range with Spotted Gum, Blackbutt and Ghost Gum all represented.



No need for adhesive

Planks simply click into place with minimal prep time.



Durable



Compatible with underfloor heating



Low maintenance



Comfortable underfoot



Realistic designs



Extra large planks



Simply score and snap. No noise, no dust.

What is Korlok?

Korlok's Premium Construction

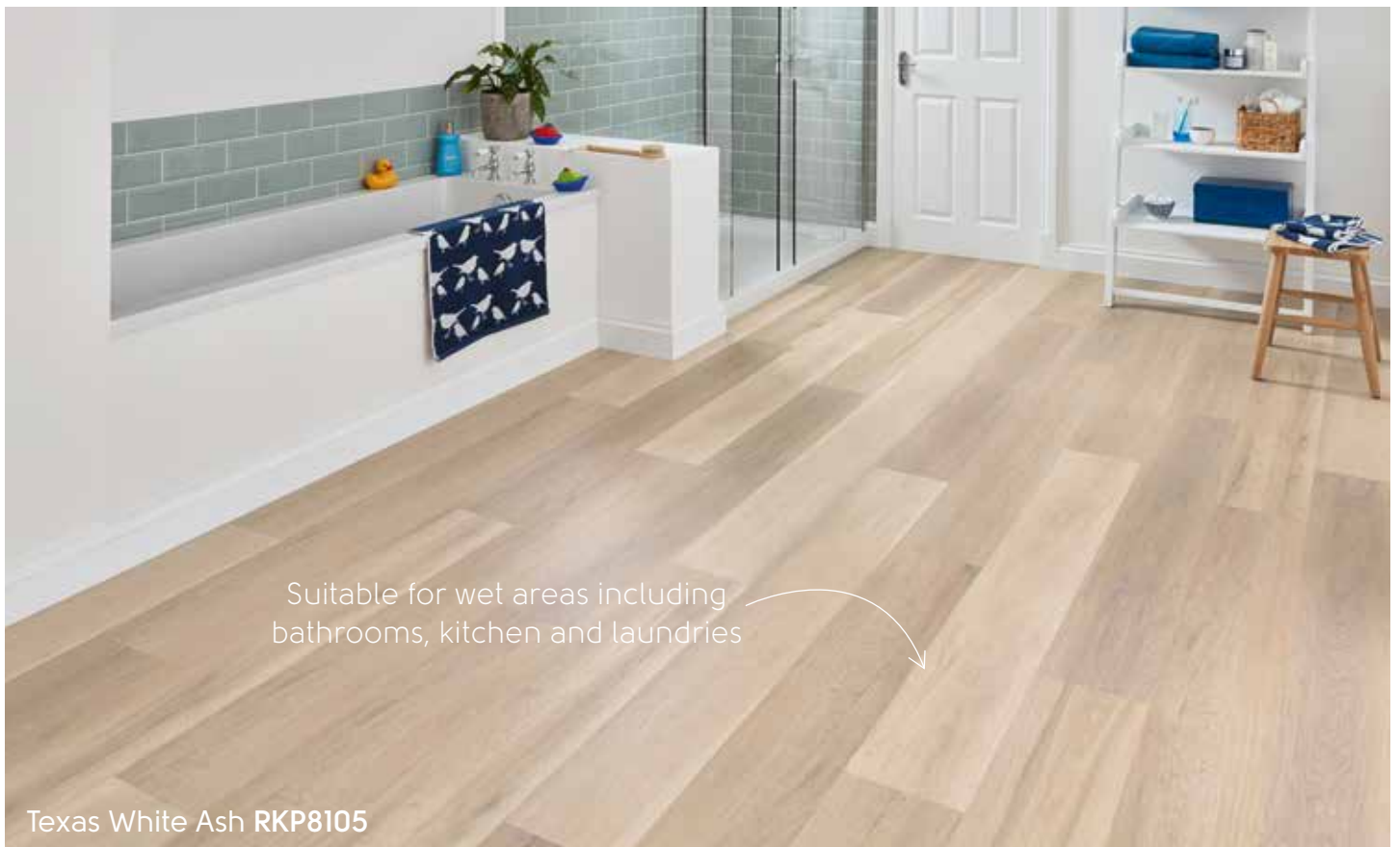
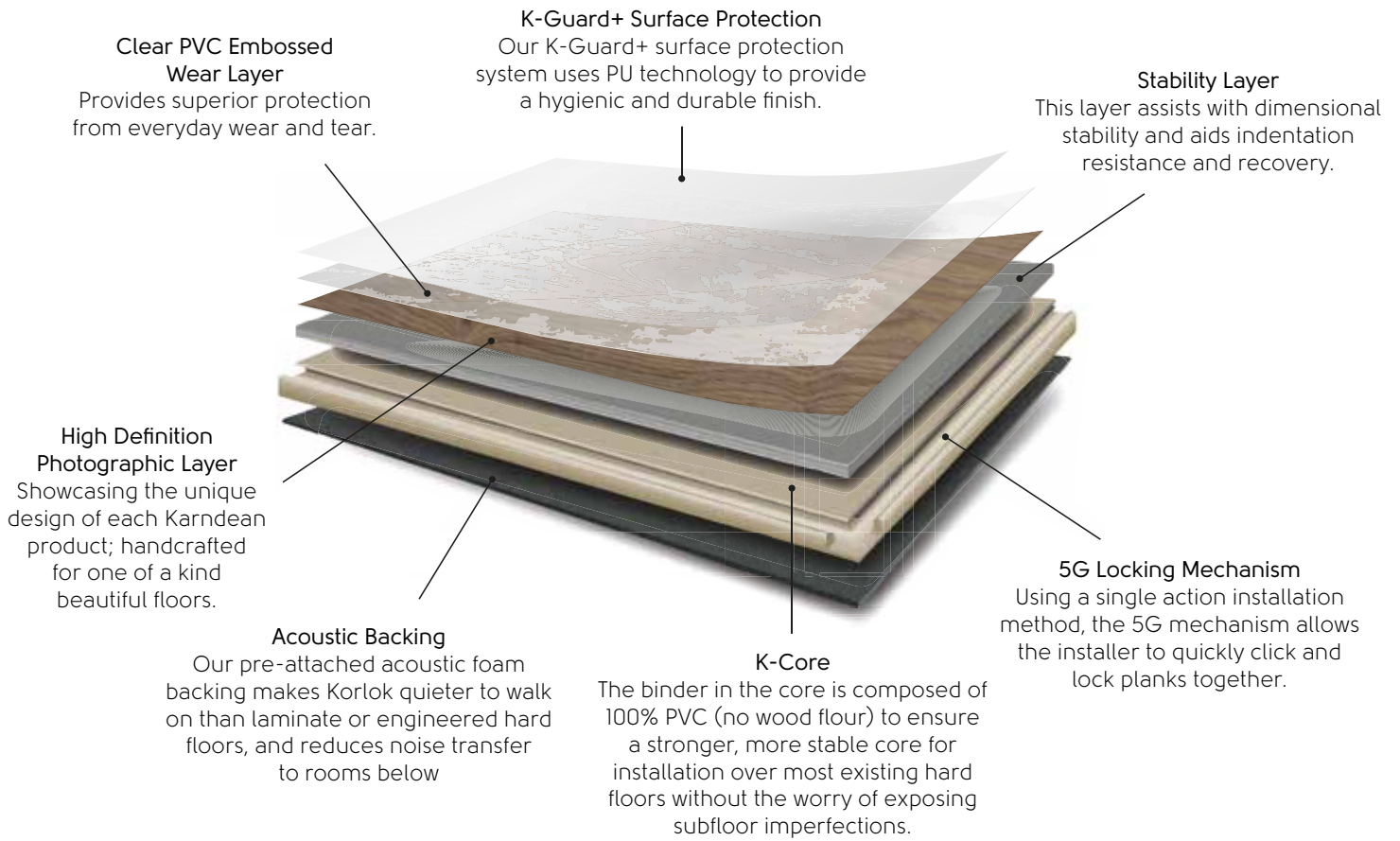



Baltic Mistral Oak RKP8112

Where is Korlok used?



Warm Spotted Gum RKP8118

Retail

With the highest abrasion wear rating (Group T) and availability in a wide range of colours and designs, you can create inspiring retail flooring designs that are not only stylish, but also durable to withstand heavy footfall. It's simple 5G lock mechanism also reduces store downtime.



Australian Ghost Gum RKP8120

Multi-Res Dwellings

Korlok's in-built acoustic backing reduces noise transfer meaning quicker installation time as well as reduced cost. It achieves an acoustic rating of 52dB compliant with national building standards.



Warm Ash RKP8103

Education

Korlok is an excellent solution for busy education environments where durability is of paramount importance. It's softer under foot than many hard floors, providing a more comfortable and quieter environment for students and faculty staff.



Weathered Spotted Gum RKP8119

Offices

Korlok is an ideal option for office flooring, creating a space that's inspiring and practical. Its 5G click locking allows the installer to quickly drop and lock planks together, meaning quicker turnaround and cost savings for your office clients.



Baltic Washed Oak RKP8101

New Housebuild

The familiar click-locking system and enhanced core technology means homeowners can achieve an authentic and luxurious Karndean floor in any space with minimal subfloor preparation, meaning less upheaval and disruption to everyday life.

Picture: With its waterproof properties, Korlok can be used in both wet and dry areas of the home to help create a consistent aesthetic throughout.



Whereas laminate is limited to dry rooms, Korlok is also waterproof which means it is suitable for wet areas including bathrooms, laundries and kitchens. Homeowners can have Korlok throughout the entire house.



Warm Ash RKP8103



Lifetime Residential
Warranty

Korlok at a glance...

1420mm x 225mm (56" x 9")



Warm Ash **RKP8103**



Natural Blackbutt **RKP8121**



Warm Spotted Gum **RKP8118**



Australian Ghost Gum **RKP8120**



Weathered Spotted Gum **RKP8119**



Smoked Blackbutt **RKP8106**



Texas White Ash **RKP8105**



Baltic Washed Oak **RKP8101**



Washed Butternut RKP8108



Washed Grey Ash RKP8104



Canadian Urban Oak RKP8116



Baltic Mistral Oak RKP8112

	Standard	Result
Size		1420 x 225 mm
Thickness	ISO 24346	6.5 mm
Box quantity		12 planks/3.15m ²
Locking system		5G
Wear layer	ISO 24340	0.5 mm
Surface treatment		K-Guard+ PU coating
Warranty	Commercial Domestic	15 year wear* Lifetime wear*
Bevelled edge		Thread
Mass per unit area	ISO 23997	7480 gm ⁻²
Standards	EN 16511	Pass:- Multilayer modular floorcovering panels
Classification	ISO 10874 Commercial ISO 10874 Domestic	33:-Commercial heavy 23:-Domestic heavy
Reaction to fire	AS ISO 9239.1 2003	CRF: Smoke value: 6.8 kW/m ² 154% min
Abrasion resistance	EN13329 Annex E	Pass 4000 cycles
Furniture chair leg	EN 424	Pass (no visible damage)
Dimensional stability	BS EN ISO 23999	Pass ≤0.25%
Impact resistance	EN13329 Annex F	Pass ≥1800 mm

Staining	EN 438-2	Pass (grade 5)
Swelling	ISO 24336	Pass (0.2%)
Light fastness	EN ISO 105-B02	Pass ≥6
Acoustic impact noise reduction	EN ISO 10140-1:2016 and EN ISO 10140-3:2010+A1:2015	ΔL _w = 19 dB
	NCC F5.3(a) requirement of ≤ 62 dB under ISO 717.2:2013 G6.3.2 impact insulation class ≥ 55 IIC	L _{nw} 52 dB
	ASTM E492-09	IIC 62
	Suitable for use on upper floors of residential high rise apartment buildings without the need for a separate acoustic underlay.	
Indentation-residual	ISO 24343-1	≤0.1 mm
Castor chair continuous use	ISO 4918/ EN 425	Pass 25,000 cycles
Thermal resistance	ISO 8302	0.052 m ² K/W Suitable for underfloor heating Max 27°C
Slip resistance**	AS4586:2013 Appendix D	R10
VOC emission	French VOC regulation (ISO 16000)	A+
Adhesive		None required; please install according to our installation instructions.
Phthalate free		Yes

*Subject to terms.

**Slip resistance is measured on ex-factory product. Slip resistance can be affected by surface contamination, use and how the product is maintained.

Korlok installation instructions with a 5G locking profile

General Information

Korlok is a fully waterproof* floating floor with excellent acoustic and thermal properties made lightweight and rigid to assist installation over uneven subfloor surfaces. It is essential that these installation instructions are followed to ensure a quality fit.

Korlok is suitable for commercial and residential use, but it is not suitable for installation outdoors nor in rooms that will be continually wet. (It is suitable for use in traditional residential bathrooms, kitchens, laundry / utility rooms).

Install permanent fixtures prior to installation of Korlok, leaving a space for expansion and contraction, see below.

Fill expansion spaces around potentially wet areas with an acrylic caulk.

A separate underlayment is not required.

Acclimatisation of material

For commercial installations make sure flooring materials are removed from packaging at least 48 hours prior to installation, (planks may be stacked, but must be rested flat) and allowed to condition in the room where the installation is to take place. Room temperature must be kept between 64-81°F (18-27°C).

For residential installations acclimatisation is not essential if the product temperature is already in the range 64-81°F (18-27°C).

To achieve a more natural look to your floor, we recommend that the product in this box is shuffled before installation.

Subfloors

Before Korlok may be installed, all subfloors should be solid and sound, smooth and level, clean and swept free of all debris. Measured moisture must be less than 95% RH, (or no more than 5 lbs. moisture/1000 ft² / 24 hours :- calcium chloride test). Any unevenness in the subfloor should be limited to a maximum of 3/16" (5 mm) below the level in any in 10' (3 m) diameter. Any isolated highpoints/ridges should first be removed in order to avoid damage to the product.

- Concrete/Screeds: For an RH between 75%-95% RH where the subfloor is uneven an appropriate smoothing compound should be selected.
- Quarry Tiles/Mosaics/Terrazzo/Ceramics: Level any grout lines with a width and/or depth of more than 0.2" (5 mm).
- Timber floors: These should be solid with little flexibility. All loose boards must be firmly fastened and gaps filled. Wood block floors laid direct to earth/bitumen/pitch must be removed prior to installation.
- Linoleum/Thermoplastic/Vinyl/Cork Floors: Make sure these floors are solid; fix any loose tiles.

- Misc.: Any existing floors installed with cutback adhesive must first be suitably covered/encapsulated.
- Metal and Painted Floors: Remove any loose paint or other finishes.
- Textile floor coverings (including carpet) must be removed.
- Underfloor Heating: it is possible to install Korlok over floors incorporating underfloor heating, but these must be insulated to keep surface temperature below 81°F (27°C).
- Electrical underfloor heating: please consult manufacturers to ensure their system is compatible with our flooring. Mesh/wire systems must be bedded into a basecoat of reinforced fiber smoothing compound. Then a second coat of primer and reinforced fiber smoothing compound should be applied.
The room temperature must be between 64-81°F (18-27°C) prior and during installation.
- Other Floors: Consult your supplier.

Installation

Korlok should be laid with an expansion gap of 0.2" (5 mm) around the perimeter of the room and all fixed objects, including pipes. This must be increased to 0.33" (8 mm) for areas larger than 1000 sqft (100 m²). Consult your supplier for larger areas.**

Skirting boards should be removed and door frames undercut to allow for possible expansion. Alternatively a suitable edge trim should be used to cover the expansion gap.

Plank products should be laid with staggered joints, at a distance of at least 10" (250 mm).

Tools

For a successful installation, the following tools will be necessary – pencil, utility knife, ruler/straight edge, carpenter's square, saw, hand roller, pull bar, hammer and rubber mallet are recommended.

Exclusions

Special care must be taken when installing Korlok in rooms that are exposed to large temperature fluctuations e.g. unheated rooms, conservatories or direct sun / through south facing patio doors. In these cases, a 0.4" (10 mm) expansion gap should be used. Adhesives are not recommended in the installation of this product.

* Water will not penetrate through the product from one side to the other. This does not include joints between individual tiles/plank.

**Where the flooring run exceeds 50 ft (15 m) in width or length, an 0.33" (8 mm) expansion joint should be used and repeated thereafter.

1. First check the width of the room and calculate how many full rows will fit; the remaining space should be halved to indicate the width of the first and last row of planks. If the space is calculated to be less than 6" (150 mm), the number of full rows should be reduced by one and the width of the cut planks in the first and last rows is increased accordingly. Install the plank with the tongue side/cut edge facing the wall, fit 0.2" (5 mm) spacers between the plank and wall (Fig. 1).
2. Lay the first row, ensuring the short edges are clicked together (Fig. 2).
3. Using a knife and straight edge, cut the last piece of the row to size making sure that there is a 0.2" (5 mm) gap between the end of the row and the wall.
4. Start the second row by clicking the tongue into the groove holding the plank at an angle (approximately 30°), then tap the plank firmly into the groove of the first row. Fit the next plank by easing the tongue and groove together on the longside. The end joint can then be tapped into position with the next plank (Fig. 3).
5. Continue to fit planks across the room until the row is complete. Where necessary, use a rubber mallet and an off-cut of the product or a hand roller to securely fix the planks together (Fig. 4 & 5). A pull bar can be used to pull the product together around the edges of the room (Fig. 6).
6. Repeat section 4 and 5 until the installation is complete.
7. Under door frames: If plank/tile cannot be lifted use an adapted tapping block (or cut off material) and mallet to carefully tap the plank/tile together flat on the floor (Fig. 7).
8. When fitting convex corners, around corners or complex profiles, mark the shape on the plank and cut using a saw.
9. Once the floor is fitted, remove the spacers; sweep the floor with a soft brush. Fix the skirting boards or suitable edge trim (available from your local dealer/distributor) to cover the expansion gaps. These should be fixed to the wall and not the floor (Fig. 8 & 9).

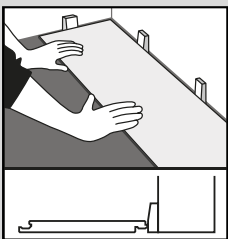

Fig. 1

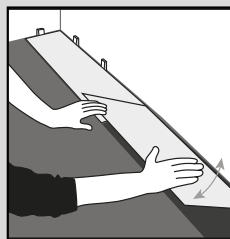

Fig. 2

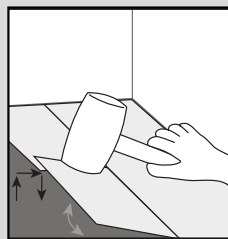

Fig. 3

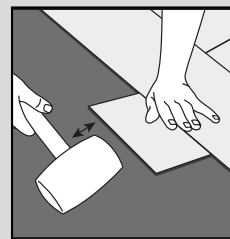

Fig. 4

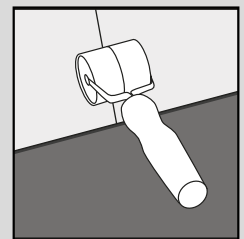

Fig. 5

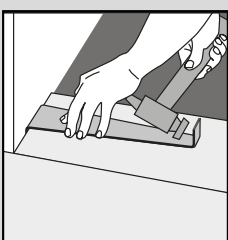

Fig. 6



Fig. 7

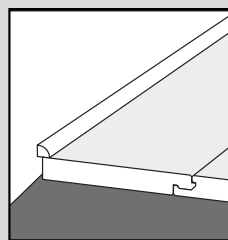

Fig. 8

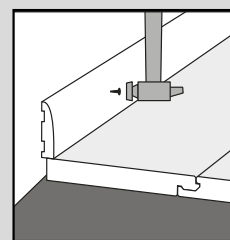

Fig. 9

Taking care of your floor

- Regularly sweep the floor to remove loose dirt or grit as these can cause fine scratches.
- For a thorough clean, a range of cleaning products is available (Clean, Remove and Refresh). Avoid the use of regular household cleaners and bleach-based detergents. These could make the floor slippery or cause discoloration.
- Always mop up spills as soon as possible, to reduce the risk of slipping and possible staining.
- Use entrance mats to protect against grit and moisture. Ensure they are of non-staining variety (not rubber-backed) to prevent any discoloration of the floor.
- Avoid sliding or dragging furniture or other objects across the floor - use floor protector pads to prevent scratching.
- Use castor cups to protect against indentation from heavy furniture.
- Maintain room temperature between 55-81°F (13-27°C) for optimum performance.
- Do not subject Korlok to standing water as this will present a slip hazard.

Korlok accessories

Add Korlok accessories to help complete the look of your Korlok floor. We have four accessories on offer, each available in the Korlok colours to complement your floor.

Scotia

Used to conceal the gap at the wall – either direct to the wall or attached to an existing skirting board.

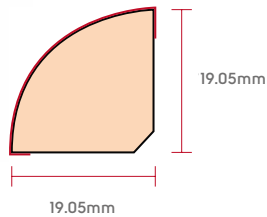

Stair Nosing

Required for both stair cases and step downs to split levels.

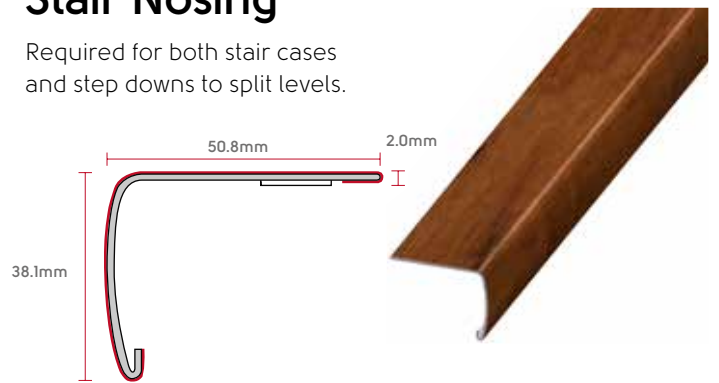

Slim Trim

Can be used in three types of applications.

Reducer

To transition from Korlok flooring to a different floorcovering or different level floorcovering/subfloor.

Expansion joint cover

Which is required for Korlok at every 15 metres in any direction.

Joint cover

For transitions between floorcoverings of similar level.

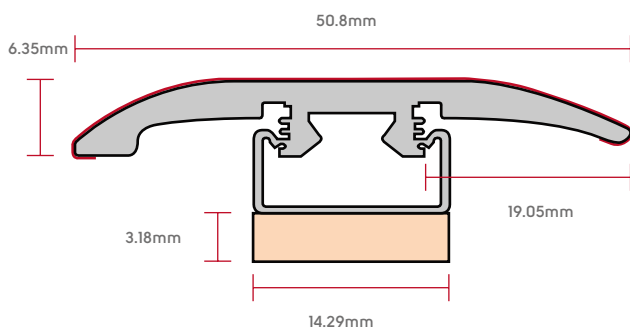

End Cap

Used to butt up to vertical edges where a Scotia is unsuitable.

For example: Aluminium door sills, ceramic tiles, aluminium angel finishes and glued carpets.

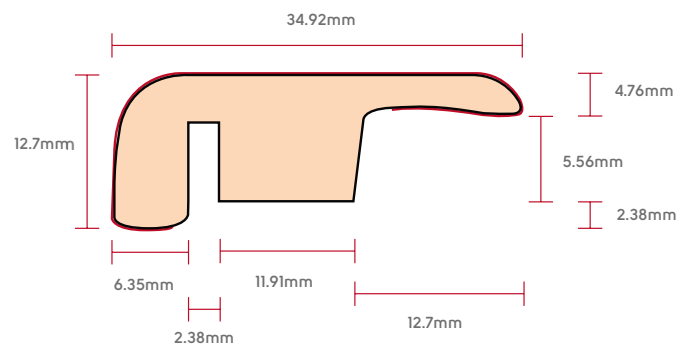

Visit us online at www.karndean.com, where you can...

Our dedicated network of commercial business managers offer the complete service to help you through your project including pricing, stock availability and technical enquiries. Book an appointment today.



Order samples

If you need some extra help selecting the best colour for your project, why not order some cutting samples? These are small samples designed to help you pick which product is right for you.



www.karndean.com/samples

Check out our helpful online tools

Not sure where to start? Use our handy Style Finder to narrow down your choices, or create Moodboards while you're browsing to save links to your favourite products, images and blog posts. Once you've narrowed down your choices, try out your favourite combinations using our Digital Specification Library.

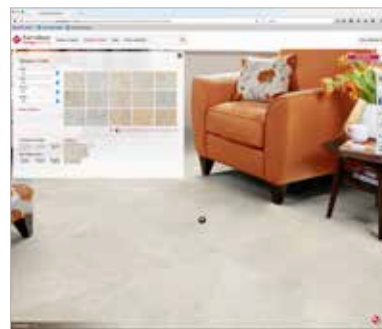





www.karndean.com/commercialmoodboard

Download the Product Selector App

The free Product Selector App for iPad showcases more than 150 wood and stone designs from our product portfolio including full technical specifications. Search 'Karndean Product Selector' on the App Store.

Keep up-to-date with us:

-  Follow us on Twitter [@karndeancomm](https://twitter.com/karndeancomm)
-  Like us on Facebook [karndeandesignflooring](https://www.facebook.com/karndeandesignflooring)
-  Follow our boards on Pinterest [karndeanfloors](https://www.pinterest.com/karndeanfloors)
-  For interior ideas follow us on Houzz [karndeandesignflooring](https://www.houzz.com/profile/karndeandesignflooring)
-  Get inspired, follow us on Instagram [karndeandesignflooring](https://www.instagram.com/karndeandesignflooring)



See our brochures for more ranges...

Karndean Designflooring offers more than 200 flooring choices across gluedown, loose lay and rigid core formats. Explore our complete range of products inspired by the look and texture of natural woods and stones.

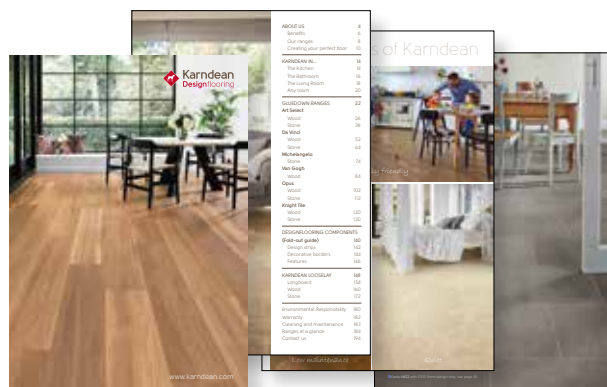



Karndean
Designflooring



Korlok Commercial

For commercial samples, literature,
sales support and technical information call
AUS: 1800 810 920 or NZ: 0800 442 101.

Visit the Karndean Designflooring website at
www.karndean.com/korlok to view the full product range,
download data sheets, read case studies and request samples.

Karndean Designflooring, 835 Stud Road Knoxfield, Victoria 3180.

www.karndean.com



green building council australia
MEMBER 2016-2017

Manufactured to ISO 9001

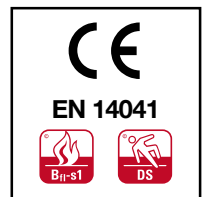

Front cover image: Baltic Washed Oak RKP8101

This page: Warm Spotted Gum RKP8118

KD3734AUS 12/17

Korlok